

## **To analyze hand gesture recognition for wirelessly electronic device control**

<sup>1</sup>Dhanashree Pannase, <sup>2</sup>Prof. Shubhangini R. Ugale

<sup>1,2</sup>Department of Electronics and Communication Engineering G.H. Raisoni Academy of engineering and technology, Nagpur

---

**Abstract:** *In this research work we propose a fast algorithm for automatically recognizing a limited set of gestures from hand images for Zig-Bee interfaced device control application. Hand gesture recognition is a challenging problem in its general form. We consider a fixed set of manual commands and a reasonably structured environment, and develop a simple, yet effective, procedure for gesture recognition. Our approach contains steps for segmenting the hand region, locating the fingers, and finally classifying the gesture. The algorithm is invariant to translation, rotation, and scale of the hand. As a part of work we also analysis the mean deviation approach with fast algorithm. From the recorded Results of hardware & software we demonstrate the effectiveness of the fast algorithm on the basis of time & accuracies. Thus the system we describe here may be the "Soft Remote Control System" which can provide easy control of home installed appliances to improve the inhabitant's comfort.*

**Keywords:** *fast algorithmic rule, Zig-Bee, mean deviation from the mean, hand gesture.*

---

### **I. Introduction**

Vision-based automatic hand gesture acknowledgement has been a very active research theme in recent years with inspiring applications such as human computer interaction (HCI), electronics device command, and signal language understanding. The general difficulty is quite demanding due a number of matters encompassing the complicated environment of static and dynamic hand signs, complex backgrounds, and occlusions. Striking the difficulty in its generality needs complicated algorithms needing intensive computer assets. Which motivates us for this work is robot navigation troubles in which we are interested in controlling an electronics apparatus by hand pose signals granted by a human. Due to real-time operational requirements we are interested in a computationally effective algorithm.

Early approaches to the hand gesture acknowledgement difficulty in a electronic apparatus command involved the use of markers on the digit tips An associated algorithm is utilised to detect the occurrence and hue of the markers , through which one can identify are hardworking in the inconvenience of putting markers on the user's hand makes this an infeasible approach in perform. Recent procedures use more sophisticated computer dream procedures and do not need markers. Hand sign recognition is presented through a curvature space procedure in which engages finding the boundary contours of the hand. This is a robust approach that is scale, translation and rotation invariant on the hand poses yet it is computationally demanding. In a vision-based hand pose acknowledgement technique utilising skeleton images is suggested, in which a multi-system camera is utilised to choose the center of gravity of the hand and points with most distant distances from the center, supplying the positions of the digit tips, which are then used to get a skeleton image, and eventually for signal acknowledgement. A method for signal acknowledgement for signal language understanding has been proposed in other computer vision.

### **II. Literature Review**

Many methods for hand sign acknowledgement using visual investigation has been suggested for hand gesture recognition. Premaratne and Q. Nguyen [1] to evolve a restricted set of hand signs that are characteristic has advanced the processing accuracy of captured gestures with less computing power. This furthermore needs a less sophisticated classification scheme utilising neural networks that does not need much processing power to work in real-time. Silas Wan and Hung T. Nguyen[2] Hand sign is a very natural form of human costly and in general do not encourage free movement of interaction and can be utilised competently in human computer interaction (HCI), utilising a little hand-worn wireless module with a 3-axis accelerometer as the shift sensor. S. Sadhana Rao[3] The sign founded expertise is utilised for kind of submissions like performing rudimentary activities, pin pointing points in the chart, watching video in report paper, dialling number in hand etc. The slight modification of this procedure leads to the use of commands that is analog data into genuine world. It permits user to connect with the internet seamlessly. Without use of keyboard, mouse we can glimpse videos get access to, change, move facts and figures simply .But this concept bottle necks lead to modification of the same by utilising instructions rather than of gestures. Muhammad Fajri Bayu Anbya [4,9] electric power supervising

system is now using real-time estimation facility via wireless network submissions. By utilising Zigbee is utilised as wireless protocol. Dominik Bunyai [5] Wireless connection has numerous interesting submissions in the area of home and building automation. in addition to the reduced power utilisation and the reduced hardware charges, ZigBee supports flexible topologies convenient for little systems where localized facts and figures are exchanged inside the network. Yikai Fang [6,9] the process of hand sign acknowledgement is very time consuming, which often brings much annoyance to users. Proposes a very quick feature detection and recount approach which can considerably speed up hand sign acknowledgement. foremost, integral likeness is used to about Gaussian derivatives to assess likeness convolution in characteristic detection. Ren, Z.[7,10] In human body following, face acknowledgement and human activity acknowledgement, robust hand sign acknowledgement continues an open difficulty. Contrasted to the whole human body, the hand is a smaller object with more convoluted articulations and more effortlessly affected by segmentation errors. It is therefore a very demanding problem to identify hand gestures. He focuses on construction a robust part-based hand gesture acknowledgement scheme using Kinect sensor.

### III. Working Methodology

Aim of the project to develop the novel method of hand gesture recognition for communication electronic device control.

According to publications reconsider we arrive into deduction that the productive locality between the interaction of hand and PC is less, We have try to increase the productive locality of the scheme by spanning successive details and numbers deduction from PC to wireless apparatus supervisor circuits.

It is an unaligned module. As it is wireless and hand gesture interfacing we are doing here for that we decode the data and with the help of zigbee we are initiating it forward.

Here the camera read the signal from the hand and then propel the sign to the design. Scheme utilizing application programs converts the signal into the command/text which is place into the transmitter brim. According to this order, it operates the appliance from the reciver brim. In this way we can command any appliance which is location at a distinct position pattern the transmitter without utilizing key board and mouse.

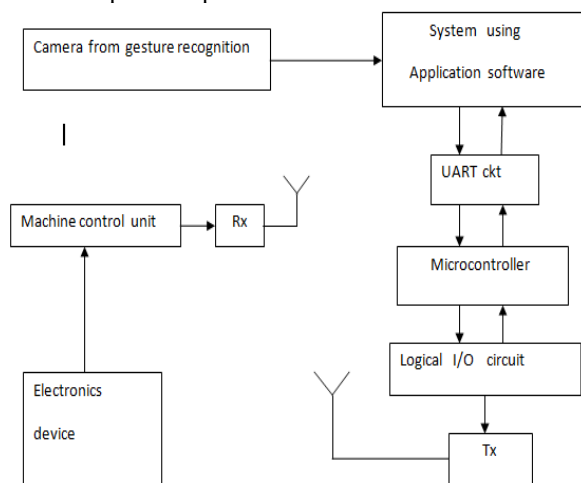

Fig.1 Basic Design of Our Concept

This paper is also deals with the design of a system that acquires a user's hand gesture and classifies it based on the predefined hand gestures, stored in a database. The figure 2 shown below is the list of gestures that the system will recognize it correctly:

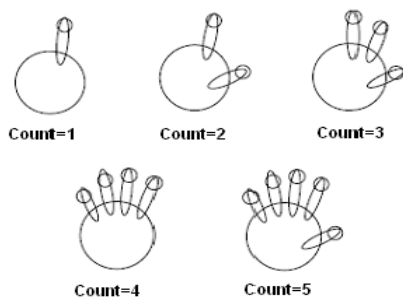

Fig.2 Gesture Representing Numbers

The work benefits low-resolution web cam for apprehending the hand signs and an algorithm that methods the came by images and then classifies the hand gesture rightly. The work mostly emphasizes on the characteristic extraction from the hand signs and use that features in the acknowledgement algorithms. Initially, the scheme will comprise a setup method, in which, the algorithm is trained founded on significant characteristic extracted for different hand signs. Once the setup in completed, the scheme will be adept to classify the granted hand sign based on the database knowledge.

This work mainly concentrates on the communication aspect of a human hand, in particular the use of hand gestures for spatial communication. A hand gesture is a meaningful part of the hand motion that can be used to express both symbolic and parametric information. We selected hand gestures as a modality to convey parametric information such as speed, angles or positions in three-dimensional space where human robot interactions take place. Key requirements for our framework are speed, accuracy, and adaptability. Speed is required for the parameters to be extracted and transferred to the robot that is moving in Real-time. Accuracy is required in two ways: recognition accuracy, and parameter extraction accuracy. In our implementation, spontaneous hand gesture is translated and recognition into particular no of count using an off-the-shelf gesture recognition in window. Work implemented for this purpose has been preceded via two main algorithm viz. Mean Deviation & Fast algorithm.

**Fast Algorithm Methodology:-**

Our proposed method of hand gesture recognition consists of the following stages:

- Localizing hand-like regions based on learned skin color statistics, producing a Black and White image output.
- Performing region-based segmentation of the hand, eliminating small false-alarm regions that were declared as “hand-like,” based on their color statistics.
- Calculating the center of gravity (COG) of the hand region as well as the farthest distance in the hand region from the COG.
- Constructing a circle centered at the COG that intersects all the fingers that are active in the count.
- Extracting a 1D binary signal by following the circle and classifying the hand gesture based on the number of active regions (fingers) in the 1D signal.

**Localizing hand-like regions by skin detection:**

We assume that the portion of the scene around the hand has already been extracted. Then our first task is to segment out the hand in the image from the background. We achieve that goal in two steps. First, we find the pixels in the scene that are likely to belong to the hand region, which we describe in this section. Then we refine that result, as we describe in the next section. It has been observed that the red/green (R/G) ratio is a discriminative characteristic feature for human skin color. Our statistical observations also support this claim. In particular, in **Figure3** , we show three images we have acquired, each containing a hand gesture, together with scatter plots of the red versus green components of the pixel intensities for skin and non-skin regions in the images. We observe that the R/G ratio stays within a narrow band of values for skin pixels, whereas it is much more variable for non-skin pixels. Therefore, we could use this ratio to decide whether a pixel is likely to belong to the hand region or not. In particular, we empirically observe that the following two thresholds successfully capture hand-like intensities:

$$1.05 < R / G < 4.00 \dots\dots (1)$$

Using this threshold in scheme, we set all the pixels with color intensities within the thresholds to one, and all the rest to zero; resulting in a black and white image output. Of course, this simple scheme could produce many erroneous decisions, for example many background pixels having skin-like colors could be classified as “hand-like.” We refine this output in the next section.

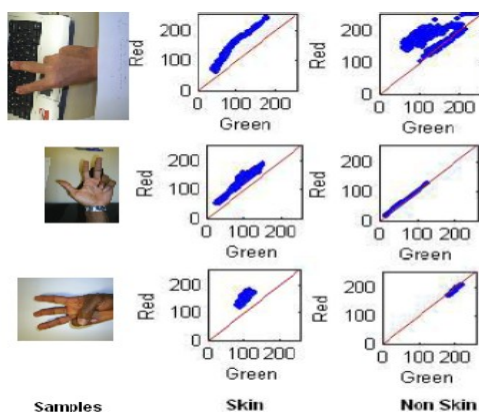

Fig. 3 Sample of skin

**Explicitly Defined Skin Region:**

To build a skin classifier is to define explicitly through a number of rules the boundaries of skin color cluster in some color space. The advantage of this method is the simplicity of skin detection rules that leads to the construction of very rapid classifier.

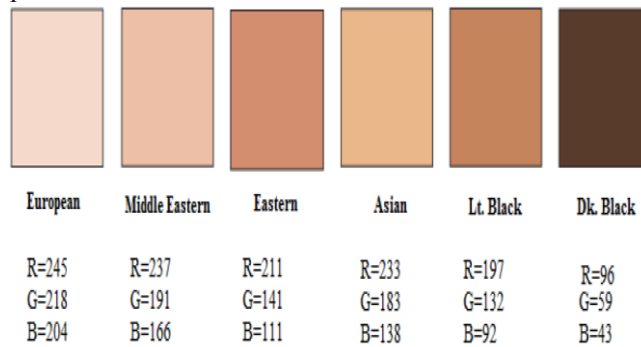

Fig4 . Different Ethnic Group Skin Patches

**(R,G,B) is classified as skin if:**  
**R > 95 and G > 40 and B > 20 and**  
**max{R,G,B} - min{R,G,B} > 15 and**  
**|R-G| > 15 and R > G and R > B**

In this classifier threshold defined to maximize the chance for recognizing the skin region for each color. If we see in **Figure4** that Red color in every skin sample is greater than 95, Green is greater than 40 and blue are greater than 20 in. So threshold can make this classifier easily detect almost all kind of skin.

**Segmentation and false-region elimination:**

The **Figure3** described in the previous section could produce many disconnected regions in the image classified as hand-like. We use ideas from region-based segmentation to all deviate this problem. Our assumption is that the largest connected white region corresponds to the hand. So we use a relative region size threshold to eliminate the undesired regions. In particular, we remove the regions that contain smaller number of pixels than a threshold value.

The threshold value is chosen as 20% of total number of pixels in the white parts. Note that this is an image-size invariant scheme. The ideal outcome is the segmented hand region.

**Finding the centroide and farthest distance:**

Given the segmented hand region **Figure 5**, from we calculate its centroide, or center of gravity (COG), (x, y), as follows:

$$\bar{X} = \frac{\sum_{i=0}^k xi}{k}, \quad \bar{Y} = \frac{\sum_{i=0}^k yi}{k}$$

Where xi and yi are x and y coordinates of the ith pixel in the hand region, and k denotes the number of pixels in the region.

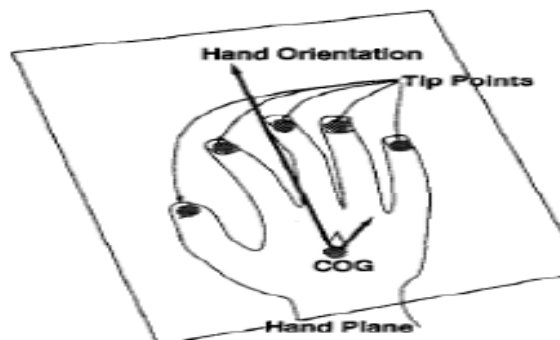

Fig.5 calculation of center of gravity

After we obtain the COG, we calculate the distance from themost extreme point in the hand to the center.

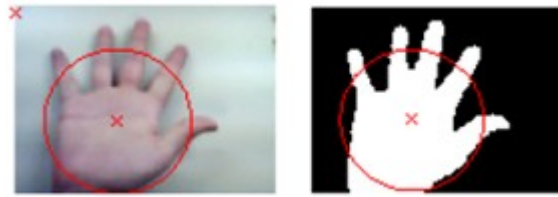

Fig.6 Calculation of farthest distance

Normally this farthest distance is the distance from the Centroid to tip of the longest active finger in the particular gesture.

#### Constructing a Circle:

We draw a circle whose radius is 0.7 of the farthest distance from the COG. Such a circle is likely to intersect the entire finger active in a particular gesture or “count.” Just to provide a visual flavor, **Figure6** demonstrates the execution of the steps described so far on a sample image.

#### Extracting a 1D Signal and Classification:

We now extract a 1D binary signal by tracking the circle **Figure7** constructed in the previous step. Ideally the uninterrupted “white” portions of this signal correspond to the fingers or the wrist. By counting the number of zero-to-one (black-to-white) transitions in this 1D signal, and subtracting one (for the wrist) leads to the estimated number of fingers active in the gesture. Estimating the number of fingers leads to the recognition of the gesture.

Note that our algorithm just counts the number of active fingers without regard to which particular fingers are active.



Fig.7 Three different ways in which our algorithm would recognize a three count, rotation, orientation

#### Scale, Rotation, and Translation Invariance:

Our proposed algorithm is scale invariant. Meaning that the actual size of the hand size and its distance from the camera do not affect interpretation.

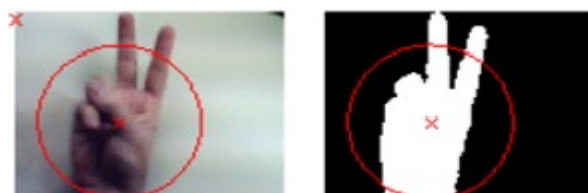

Fig8. Actual size of the hand and its distance from the camera

It is rotation invariant, since the orientation of the hand does not hinder the algorithm from recognizing the gesture. In addition, the position of hand is also not a problem.

Determination of distance between centroid and finger tips: The distance between the centroid and the fingertip is calculated using Euclidean distance shown below:

$$\text{Distance, } D_2 = (x_2 - x_1)^2 + (y_2 - y_1)^2$$

Where  $(x_1, x_2)$  and  $(y_1, y_2)$  represent the two co-ordinate values. Here one pair represents fingertip location and other pair represents centroid location.

#### Mean And Standard Deviation Methodology:-

In the pre-processing phase, doing several step like removing the background and RGB image is converted into grayscale type as done in the previous algorithm. The edge of the grayscale image is taken with a fixed threshold i.e. 0.5 then calculate the mean and standard deviation the processed image.

Mean is calculated by taking a sum of all the pixel values and dividing it by the total no of values in the matrix. Mathematically, it is defined as:

$$\bar{X} = \sum_{i=1}^n Xi / n$$

Stand Deviation can calculate from mean which is mathematically defined as:

$$s = \sqrt{\frac{\sum_{i=1}^n (x_i - \bar{x})^2}{n}}$$

The mean and standard deviation of each type of count gesture are given to the neural network for training. In the end, the system is tested to see the success rate of classification this technique provides. Mathematically, the input given to the neural network is defined as:

Input to NN= Mean (Edge (Binary image)) + S.D (Edge (Binary Image))

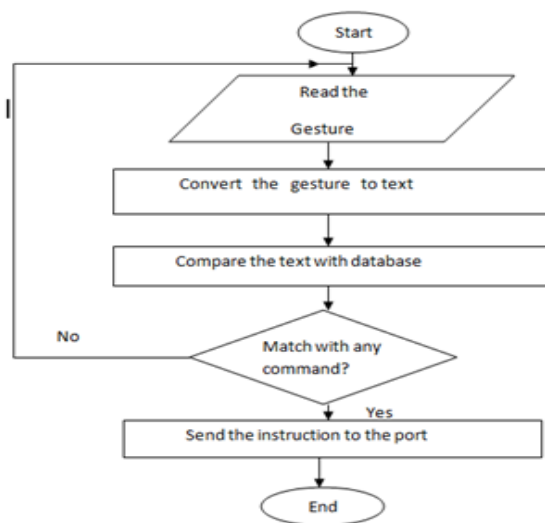

Fig.9 General flow diagram of a System

#### IV. Implementation And Result

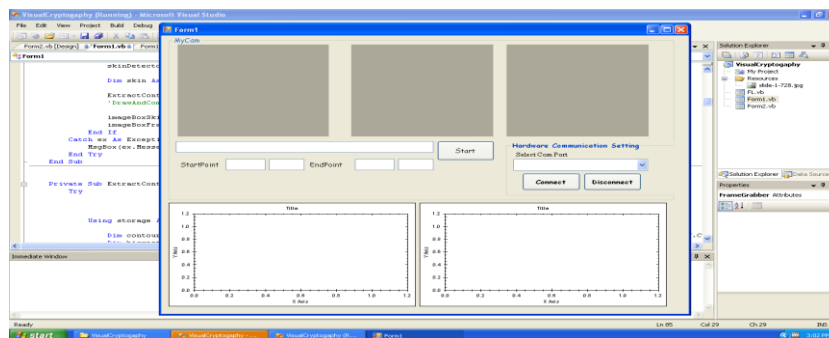

Fig.A Form design in vb.net

Above **Figure A** shows the complete design of form in vb.net .This form developed in vb.net using various toolboxes. In this form we make the use of image box skin , image box frame grabber, image box 1, text box, start button, combo box , tow zed graph control ,connect button ,disconnect button and in vb.net coding of this toolbox is created at the back end of the tools.

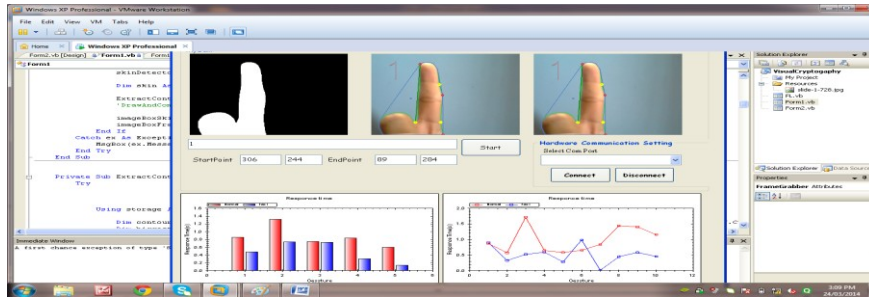

Fig.B Count one detected

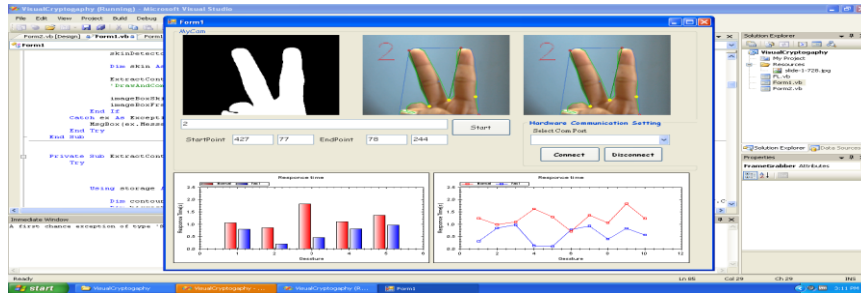

Fig.C Count two detected

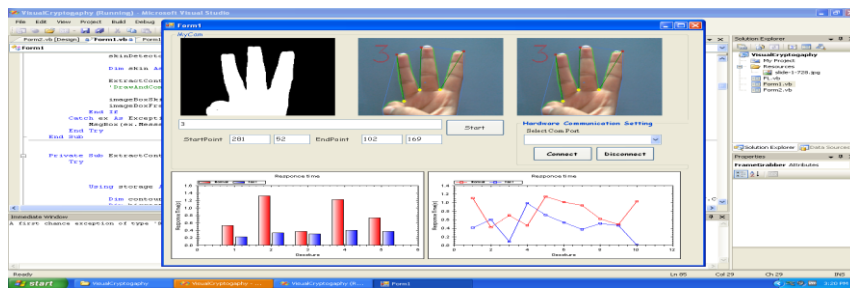

Fig.D Count three detected



Fig.E Count four detected

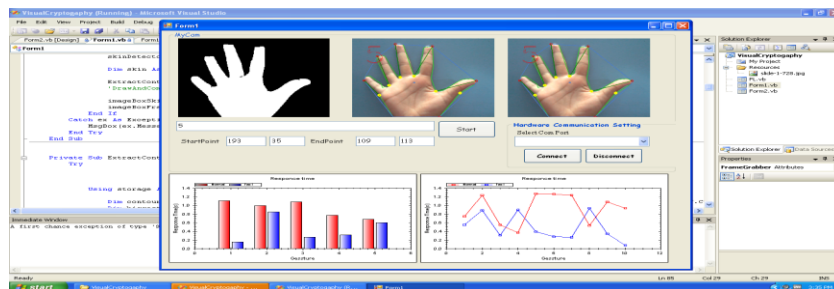

Fig.F Count five detected

From the above **Figure A,B,C,D,E,F** they can view windows, first window shows the segmented picture, second window shows the gesture form fast optimal algorithm, third window shows the gesture from standard deviation.

Below this there is result. The bar graph shows the actual time results, where x-axis shows the gesture and y-axis shows the time necessary to calculate the gesture. Red bar shows the time necessary for gesture recognition for standard deviation process calculation and blue bar shows the time necessary for the fast optimal algorithm. From this graph shows time necessary for fast optimal algorithm is less than the standard deviation algorithm.

Second graph is for run time, x-axis shows gesture and y-axis shows the necessary time, red line is for standard deviation algorithm and fast optimal algorithm is represented by the blue line.

Hence this shows that the overall time required for the gesture recognition is less for the fast optimal algorithm as compared to standard deviation algorithm.

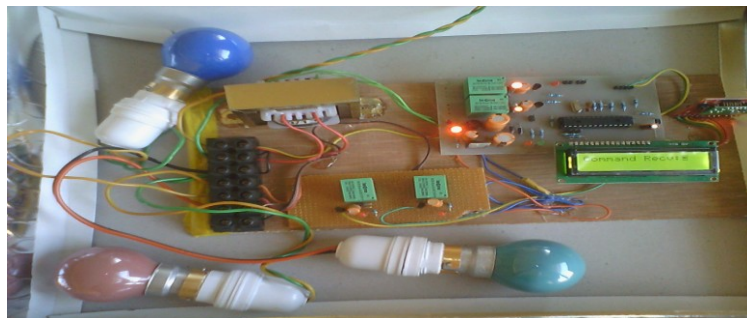

Fig.G Hardware implemented

**Figure G,H** shows the fittings actualized where 4 switches are associated and 3 bulbs are joined with them. These bulbs will get turn on and off as per the signal of hands. At the point when motion indicates the five fingers then all the switches will be off, means all knobs are off around then. At the point when four fingers are identified then 2 switches will be ON means 2 bulbs are ON. What's more when three fingers third bulb will get ON means switch no 3rd is turn ON. Essentially for when 2 fingers distinguished fourth switch will be ON. For one and zero the switches will be constantly in NO operation, implies NO one switch will get respond and will be in their state.



Fig.H The command from two fingers gesture 3 switches are ON

**Figure H** shows the complete hardware and software interfacing.

From the **Figure H** it is clear that when software recognizes the two fingers then four switches are ON. Which is indicated by the bulbs because bulbs will get ON only when switch is ON.















There is column for hardware connectivity port, where they have connected the hardware port. So the gesture recognition will be used for the electronics device control (which is shown in the **Figure. H**).

Table I Analysis of two methods

Algorithm	Fast optimal	Standard deviation
Deviation rate	Decrease (0.1 to 0.71)	Increase (0.3 to 0.6)
Time	Time delay sampling count reduce	Increase
Utility	For hand recognition	For overall gesture recognition
Result analysis	Real time count	Run time count



Table II Results

Types of hand gesture			Time required for gesture capture	Time required for gesture capture
Segmented image	Fast optimal image window	Standard deviation image window		
			0.8976	1.3888
			0.5525	1.4090
			0.9347	1.5832
			0.8726	1.147
			0.8252	2.2266

## V. Applications

This structure is little more than the change. We can alter it by utilizing GSM (global scheme for wireless communication) to construct the parting in future. This structure is use for the impediment persons additionally, without development can work. Up to this there was a constraint control structures are accessible, although we illustrating isolated control provision.

## VI. Conclusions

We proposed a fast and mean deviation algorithm for a hand gesture recognition problem. Given observed images of the hand, the algorithm segments the hand region, and then makes an inference on the activity of the fingers involved in the gesture. We have demonstrated the effectiveness of this computationally efficient algorithm on real images we have acquired. Based on our motivating robot control application, we have only considered a limited number of gestures. Our algorithm can be extended in a number of ways to recognize a broader set of gestures. The segmentation portion of our algorithm is too simple, and would need to be improved if this technique would need to be used in challenging operating conditions. However we should note that the segmentation problem in a general setting is an open research problem itself. Reliable performance of hand gesture recognition techniques in a general setting require dealing with occlusions, temporal tracking for recognizing dynamic gestures, as well as 3D modeling of the hand, which are still mostly beyond the current state of the art.

## Acknowledgment

I would like to express heartfelt gratitude towards my faculty guide, Prof. Shubhangini R. Ugale Faculty, Electronics & Communication Department.

## References

- [1] P. Premaratne and Q. Nguyen, "Consumer electronics control system based on hand gesture moment invariant", *IET Computer Vision*, 1(1), 2007, 35-41.
- [2] Silas Wan and Hung T. Nguyen "Human Computer Interaction using Hand Gesture" Engineering in Medicine and Biology Society. EMBS 2008 30th Annual International Conference of the IEEE 2008.
- [3] S. Sadhana Rao, "Sixth Sense Technology", Proceedings of the IEEE International Conference on Communication and Computational Intelligence – 2010, Kongu Engineering College, Perundurai, Erode, T.N., India.27 – 29 December, 2010.pp.336-339.
- [4] Muhammad Fajri Bayu Anbya, et al., "Wireless Sensor Network for Single Phase Electricity Monitoring System via Zigbee Protocol" 2012 IEEE Conference on Control, Systems and Industrial Informatics (ICCSII) Bandung, Indonesia, September 23-26, 2012.
- [5] Dominik Bunyai, Lukas Krammer, Wolfgang Kastner "Limiting Constraints for ZigBee Networks" Vienna University of Technology, Automation Systems Group 978-1-4673-2421-2/12/\$31.00 2012 IEEE.
- [6] Yikai Fang "Hand Gesture Recognition Using Fast Multi-scale Analysis" Image and Graphic 2007. ICIG2007. Fourth International Conference.
- [7] Ren, Z "Robust Part-Based Hand Gesture Recognition Using Kinect Sensor" Multimedia, IEEE Transactions on (Volume: 15, Issue: 5)2013IEEE.
- [8] Iгореvich, R.R. "Hand gesture recognition algorithm based on grayscale histogram of the image" Application of Information and Communication Technologies (AICT), 2010 4th International Conference on 12-14 Oct. 2010

- [9] Ruize Xu "MEMS Accelerometer Based Nonspecific-User Hand Gesture Recognition" *Sensors Journal, IEEE* (Volume: 12, Issue: 5) May 2012
- [10] Panwar, "M. Hand gesture recognition for human computer interaction" *Image Information Processing (ICIIP), 2011 International Conference on* 3-5 Nov. 2011
- [11] Qiong Fei "Real-time Hand Gesture Recognition System Based on Q6455 DSP Board" *Intelligent Systems, 2009. GCIS '09. WRI Global Congress on* (Volume:2 )19-21 May 2009.
- [12] Yi Li "Multi-scenario gesture recognition using Kinect" *Computer Games (CGAMES), 2012 17th International Conference on* July 30 2012-Aug. 1 2012.
- [13] Van den Bergh, M. "Real-time 3D hand gesture interaction with a robot for understanding directions from humans" *RO-MAN, 2011 IEEE* July 31 2011-Aug. 3 2011.
- [14] S. Soutschek, J. Penne, J. Hornegger, J. Kornhuber, "3-d gesture-based scene navigation in medical imaging applications using Time-of-Flight cameras", *Proc. of the IEEE Computer Society Conference on Computer Vision and Pattern Recognition Workshops*, 1-6, 2008.
- [15] Van den Bergh, M. "Haarlet-based hand gesture recognition for 3D interaction" *Applications of Computer Vision (WACV), 2009 Workshop on* 7-8 Dec. 2009.
- [16] M. Van den Bergh, L. Van Gool, "Combining RGB and ToF Cameras for Real-time 3D Hand Gesture Interaction", *Comput. J., Proc. of the IEEE Workshop on Applications of Computer Vision (WACV), 2011*.
- [17] Mester, G. "Wireless sensor-based control of mobile robots motion" *Intelligent Systems and Informatics, 2009. SISY '09. 7th International Symposium on* 25-26 Sept.2009.
- [18] Wei Lun Ng "Home appliances controller using wireless controller area network (WCAN) system" *Computer and Communication Engineering (ICCCE), 2010 International Conference on* 11-12 May 2010.